

No-Frost
Refrigerator-Freezer

Use and Care Guide

ROPER[®]

Home Appliances

RB22CK

Thank you for choosing a Roper Appliance.

This Use and Care Guide will help you operate and maintain your new, quality-built Roper refrigerator-freezer. Keep this Use and Care Guide in a safe place for future reference.

Complete and mail the Product Registration Card.

This card enters your warranty into our warranty system that ensures efficient claim processing, can be used as a proof of purchase for insurance claims and helps Roper to contact you immediately in the unlikely event of a product-safety recall.

You are responsible for

It is your responsibility to be sure your refrigerator:

- Has been properly installed and leveled according to the installation instructions given on page 2.
- Is installed on a floor that can support the weight of the refrigerator.
- Is properly connected to a grounded electrical circuit that meets the electrical requirements on page 2.
- Is properly used only for the job it was designed to do.
- Is not used by children or anyone unable to operate it properly.
- Is cold in both the refrigerator and freezer sections before food is added.
- Is properly maintained.

Contents

	Page
Important Safety Instructions	2
Before Using Your Refrigerator	2
Parts and Features	3
Using Your Refrigerator	4
Setting the controls	4
Changing control settings	4
Exterior moisture control	4
Adjusting refrigerator shelves	4
Removing meat drawer and cover	5
Removing crispers and crisper cover	5
Removing freezer basket	5
Changing the light bulbs	5
Removing the base grille	5
Reversing the door swing	5
Ice cube trays	5
Optional automatic ice maker	6
Food Storage Guide	6
Cleaning Your Refrigerator	7
Caring For Your Refrigerator	8
If electricity goes off	8
Vacation and moving guide	8
Normal operating sounds	8
Energy saving tips	8
Before You Call For Service	9
Warranty	12
How to get service or assistance	12

Important Safety Instructions

⚠ WARNING

To reduce the risk of fire, electrical shock, or injury when using your refrigerator, follow basic precautions including the following:

1. Read all operating instructions before using your refrigerator.
2. Child entrapment and suffocations are not problems of the past. Junked or abandoned refrigerators are still dangerous ... even if they will "just sit in the garage for a few days."

If you are getting rid of your old refrigerator, do it safely. Please read the enclosed safety booklet from the Association of Home Appliance Manufacturers. Help prevent accidents.

3. Never allow children to operate, play with, or crawl inside the refrigerator.

4. Never clean refrigerator parts with flammable fluids. The fumes can create a fire hazard or explosion.

**▪ FOR YOUR SAFETY ▪
DO NOT STORE OR USE GASOLINE OR OTHER FLAMMABLE VAPORS AND LIQUIDS IN THE VICINITY OF THIS OR ANY OTHER APPLIANCE. THE FUMES CAN CREATE A FIRE HAZARD OR EXPLOSION.**

▪ SAVE THESE INSTRUCTIONS ▪

Before Using Your Refrigerator

A. Remove labels

Remove the tape and any inside labels before using the refrigerator. To remove any remaining glue:

- Rub briskly with thumb to make a ball, then remove.

OR

- Soak area with liquid hand dishwashing detergent before removing glue as described above.

Do not use sharp instruments, rubbing alcohol, flammable fluids or abrasive cleaners. These can damage the material. See "Important Safety Instructions" above.

NOTE: Do not remove the Tech Sheet located on the bottom of the refrigerator.

B. Clean it

Clean your refrigerator before using it. See cleaning instructions on page 7.

C. Plug it in

Recommended Grounding Method

A 115 Volt, 60 Hz., AC only, 15 or 20 ampere fused and properly grounded electrical supply is required. It is recommended that a separate circuit serving only this appliance be provided. Use a receptacle which cannot be turned off with a switch or pull chain. Do not use an extension cord.

See Electrical Requirements and Grounding Instructions Sheet in literature package for complete details.

D. Install properly

Install the refrigerator according to the dimensions shown below.

Leave extra space along the hinge-side wall to allow the door to be opened wider.

Do not install the refrigerator:

- next to an oven, radiator or other heat source;
- out in the weather or direct sunlight;
- in an area where the room temperature will fall below 55°F (13°C).

Allow ½ inch (1.25 cm) space on each side and at the top of the refrigerator for ease of installation.

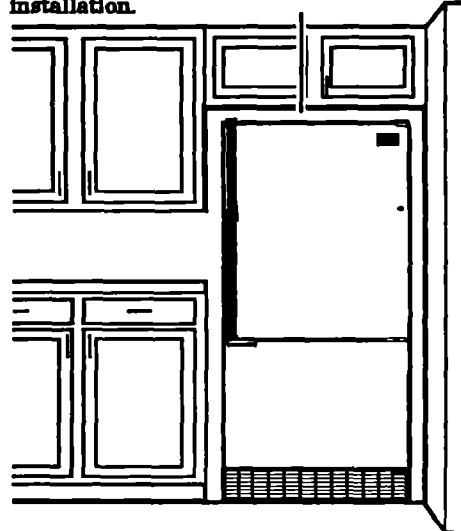

The refrigerator can be flush against the back wall.

E. Level refrigerator

Make sure the refrigerator is level for efficient operation.

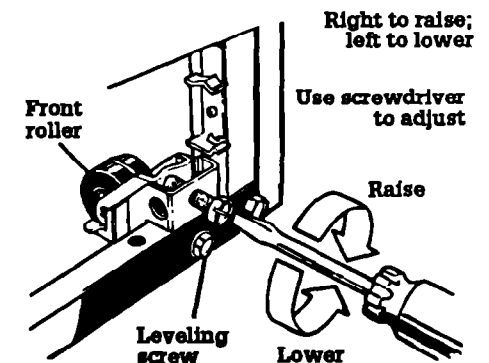

1. Remove base grille. (See page 5.)
2. To raise front, turn screw in direction shown.
3. To lower front, turn screw in direction shown.
4. Replace base grille. (See page 5.)

Parts and Features

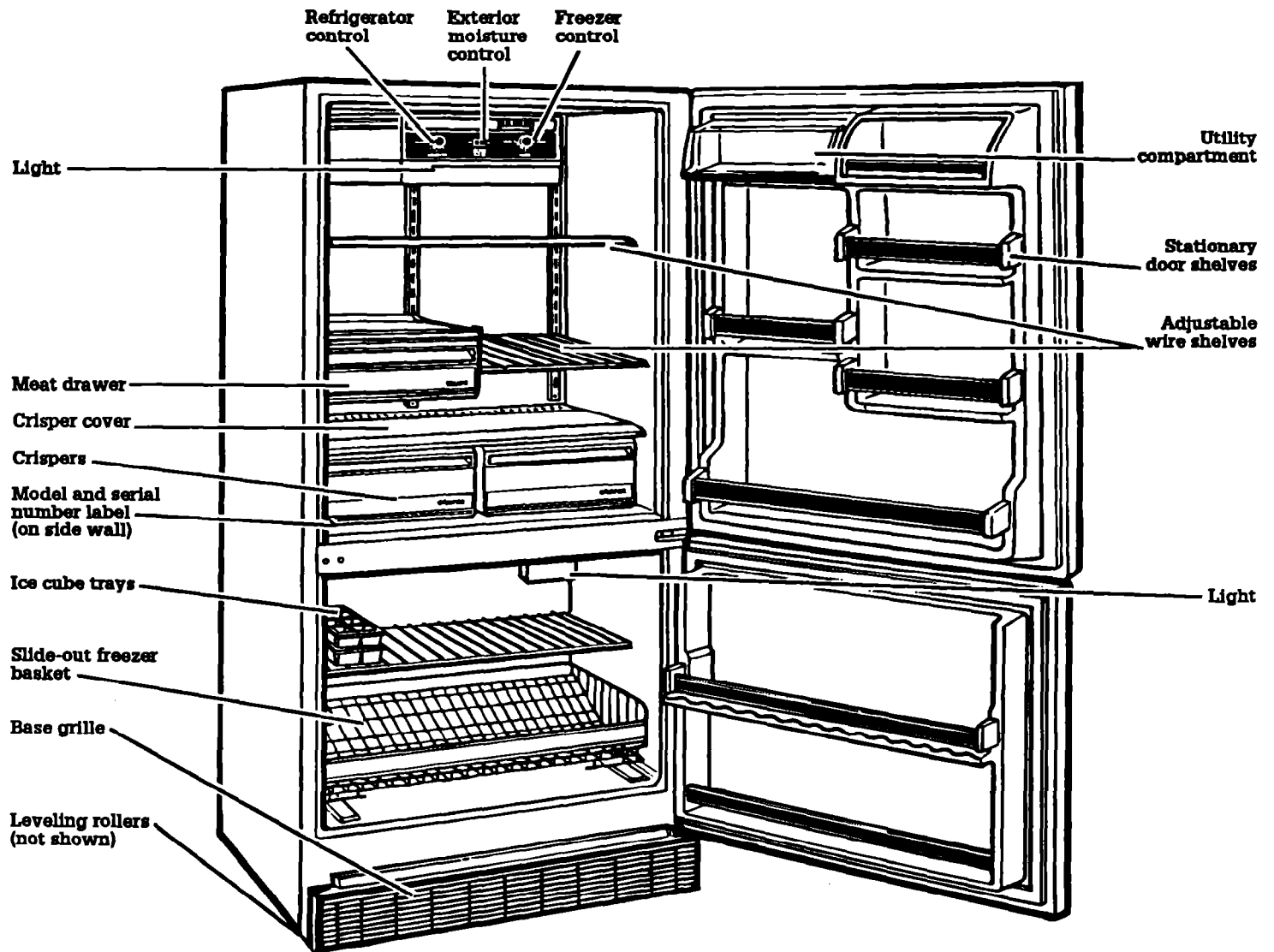

Using Your Refrigerator

Setting the controls

Controls for the refrigerator and freezer are in the refrigerator. When the refrigerator is plugged in for the first time:

1. Set the Refrigerator Control to 3.
2. Set the Freezer Control to B.

3. Let the refrigerator and freezer compartments get cold for several hours before adding food.
4. When the refrigerator keeps milk or juice as cold as you like and the freezer compartment keeps ice cream firm, the settings are correct for your household.

Changing control settings

1. Adjust the Refrigerator Control according to the settings listed in the chart below.
2. Wait 24 hours or more before making additional adjustments to the Refrigerator Control or adjusting the Freezer Control.

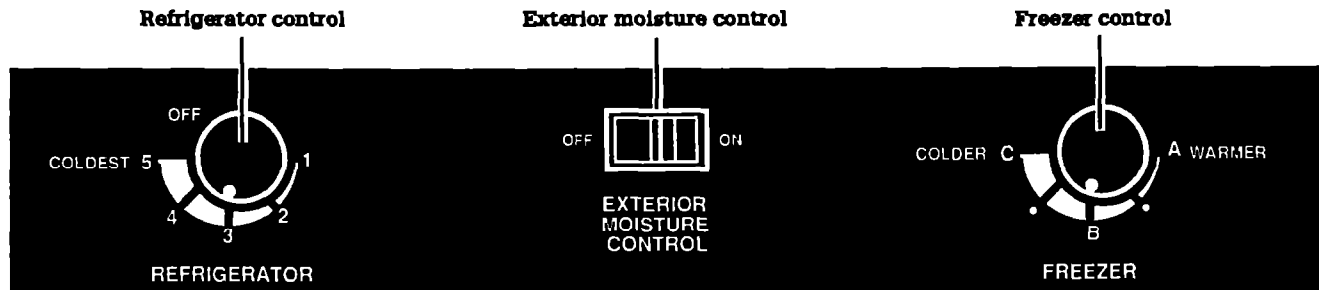

Condition	Check if	Set control setting
Refrigerator section TOO WARM	<ul style="list-style-type: none"> ▪ Door is opened often. ▪ Large amount of food added. ▪ Too-warm room temperature. 	Refrigerator 4 Freezer B
Freezer section TOO WARM	<ul style="list-style-type: none"> ▪ Door is opened often. ▪ Large amount of food added. ▪ Too-cold room temperature (freezer can't cycle often enough). 	Refrigerator 3 Freezer Between B and C
Both sections TOO WARM	<ul style="list-style-type: none"> ▪ Door is opened often. ▪ Large amount of food added. ▪ Too-warm or too-cold room temperatures. 	Refrigerator 2 Freezer B
Refrigerator section TOO COLD	<ul style="list-style-type: none"> ▪ Controls not set correctly. 	Refrigerator 4 Freezer Between B and C
Ice is not made fast enough	<ul style="list-style-type: none"> ▪ Heavy ice usage. ▪ Very cold room temperature (freezer can't cycle often enough). 	Refrigerator 3 Freezer Between B and C

Exterior moisture control

The Exterior Moisture Control operates electric heaters around the door openings. These heaters help keep moisture from forming on the outside of the refrigerator.



1. Use the OFF setting when humidity is low.
2. Use the ON setting if moisture forms on the outside of the refrigerator.

Adjusting refrigerator shelves

Shelves can be adjusted to match the way you use your refrigerator.

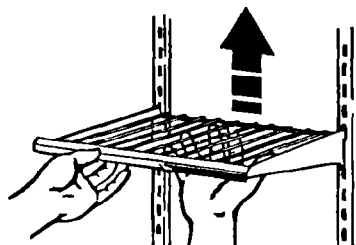

To remove shelf:

1. Remove food from shelf.
2. Tilt up at front.
3. Lift up at back.
4. Pull shelf straight out.

To replace shelf:

1. Guide the rear hooks into the slots in the shelf supports.
2. Tilt up front of shelf until hooks drop into slots.
3. Lower front of shelf into position.

Removing meat drawer and cover

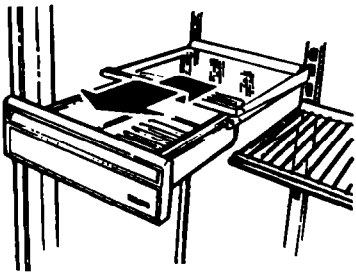

To remove meat drawer:

1. Slide out to the stop.
2. Lift the front.
3. Slide out the rest of the way.
4. Replace in reverse order.

To remove cover:

1. Tilt front of cover up, lift at back and pull straight out.
2. Replace in reverse order.

Removing crispers and crisper cover

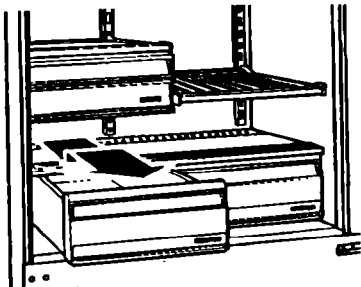

To remove crisper:

1. Slide out to the stop.
2. Lift the front.
3. Slide out the rest of the way.
4. Replace in reverse order.

To remove cover:

1. Push up glass insert from bottom, then lift out with two hands.
2. Lift front of cover frame.
3. Pull cover frame up and out.
4. Remove metal cover support.

To replace cover:

1. Replace metal cover support on wall supports in front section of cabinet.
2. Fit back of cover frame into notch supports on walls of refrigerator, then lower into place.
3. Slide back of glass insert into place, then lower front.

Removing freezer basket

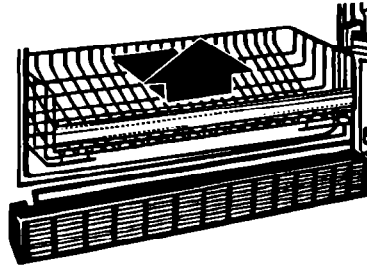

To remove basket:

1. Slide out to the stop.
2. Lift the front to clear the stop.
3. Slide out the rest of the way.

To replace basket:

1. Place basket on the slides.
2. Make sure the wire stops clear the front of the slides.
3. Slide basket in.

Changing the light bulbs

⚠ WARNING

Electrical Shock Hazard
Unplug the refrigerator or disconnect the main electric power supply to the refrigerator before changing a bulb. Failure to do so could result in electrical shock or injury.

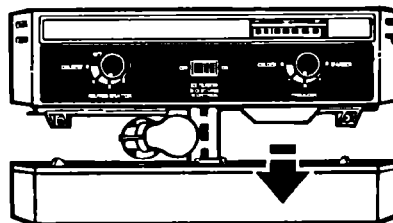

To change refrigerator light:

1. Disconnect refrigerator from power supply.
2. Push lightly on the top center of the light shield until the notched tab unhooks from the control panel.
3. Pull down on the light shield until the tab clears the control panel.
4. Lift back hooks out of their slots.
5. Remove bulb and replace with a 40-watt appliance bulb.
6. Replace light shield in reverse order.
7. Reconnect power supply.

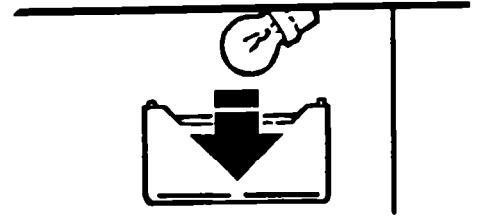

To change freezer light:

1. Disconnect refrigerator from power supply.
2. Push in sides of light shield until it snaps free.
3. Replace bulb with a 40-watt appliance bulb.
4. Snap light shield into place.
5. Reconnect power supply.

NOTE: Not all commercial appliance bulbs will fit your refrigerator. Be sure to replace a bulb with one of the same size and shape.

Removing the base grille

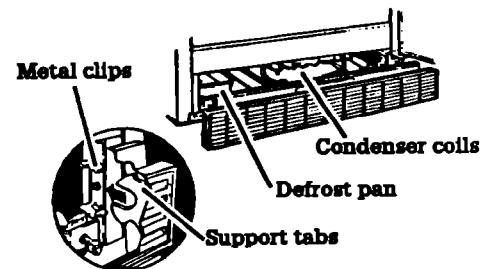

To remove grille:

1. Open freezer door.
2. Pull grille out.
3. Do not remove Tech Sheet fastened behind grille.

To replace grille:

1. Line up grille support tabs with metal clips.
2. Push firmly to snap into place.
3. Close the door.

See cleaning instructions for defrost pan and condenser coils on page 7.

Reversing the door swing

You can change the hinges on your refrigerator so the doors open the other way. Refer to the instruction sheet included with your refrigerator.

Ice cube trays

Remove ice by slightly twisting the tray with both hands.

NOTE: The longer ice cubes are stored, the smaller they get. Slow evaporation is caused by the movement of cold air.

Optional automatic ice maker

If you have the automatic ice maker accessory (Part No. ECKMF-90) or if you plan to add it later, there are a few things you will want to know:

- Connect the ice maker to the water supply before turning it on. Instructions for ice maker water supply hook-up are attached to the back of the refrigerator cabinet.
- The ON/OFF lever is a wire signal arm. Lower signal arm to make ice. Raise signal arm to turn off the ice maker.
- Freezer must be cold enough for the ice maker to work. This may take eight hours or more before the correct temperature is reached.
- "First" ice may be discolored or off-flavored because of new plumbing connections. Throw away first few batches of ice.
- Change ice cube size with the dial or lever on the side of the ice maker.
- Ice crescents are normally attached at the corner. They break apart easily.
- Normal sounds include water running when the ice maker is working and the thud of ice as it falls into the bin.
- If ice is not being made fast enough and more ice is needed, turn the Refrigerator Control to a higher number. Wait 24 hours, and if this does not increase the ice supply, turn the Freezer Control to A.
- Raise the signal arm before you remove the ice bin. When you replace the bin, push it in all the way. Then lower the arm to the ON position.
- Cubes left in the bin for long periods of time may develop an off-flavor, like stale water. Throw old cubes away. Ice maker will make new ice. Cubes may also become smaller if stored for a long time.
- Good water quality is important for good ice quality. It is not recommended that you connect the ice maker to a softened water supply. If a softened water supply cannot be avoided, it is important to maintain the water softener so it operates properly. Water softener chemicals, such as salt from a malfunctioning softener, can damage the ice maker mold and lead to poor ice quality.

Food Storage Guide

Storing fresh food

Food placed in the refrigerator should be wrapped or stored in air and moisture proof material. This prevents food odor and taste transfer throughout the refrigerator. For dated products, check code date to ensure freshness.

Vegetables

For leafy vegetables: remove store wrapping and trim or tear off bruised and discolored areas. Wash in cold water and drain. Place in plastic bag or plastic container and store in crisper.

For vegetables with skins: store in crisper, plastic bags or plastic container.

Fruit

Wash, let dry and store in refrigerator in plastic bags or crisper. Do not wash or hull berries until they are ready to use. Sort and keep berries in their store container in a crisper, or store in a loosely closed paper bag on a refrigerator shelf.

Eggs

Store without washing in the original carton on interior shelf.

Milk

Wipe milk cartons. For best storage, place milk on interior shelf.

Butter or margarine

Keep opened butter in covered dish or butter compartment. When storing an extra supply, wrap in freezer packaging and freeze.

Cheese

Store in the original wrapping until you are ready to use it. Once opened, rewrap tightly in plastic wrap or aluminum foil.

Meat

Most meat can be stored in original wrapping as long as it is air and moisture proof. Rewrap if necessary. See the following chart for storage times.

Fresh and cured meat storage chart*

TYPE	APPROXIMATE TIME (DAYS)
Chicken.....	1 to 2
Ground beef	1 to 2
Steaks and roasts.....	3 to 5
Cured meats.....	7 to 10
Bacon	5 to 7
Cold cuts.....	3 to 5
Variety meats.....	1 to 2

*If meat is to be stored longer than the times given, follow the directions for freezing.

NOTE: Fresh fish and shellfish should be used the same day as purchased.

Leftovers

Cover leftovers with plastic wrap or aluminum foil. Plastic containers with tight lids can also be used.

Storing frozen food

The freezer section is designed for storage of commercially frozen food and for freezing food at home. For further information about preparing food for freezing or food storage times, contact your local Cooperative Extension Service or check a freezer guide or cookbook.

Packaging

The secret of successful freezing is in the packaging. The way you close and seal the package must not allow air or moisture in or out. Packaging done in any other way could cause food odor and taste transfer throughout the refrigerator and drying of frozen food.

Rigid plastic containers with tight fitting lids, straight-sided canning/freezing jars, heavy-duty aluminum foil, plastic-coated paper and nonpermeable plastic wraps (made from a saran film) are recommended. Follow package or container instructions for proper freezing methods.

Do not use: bread wrappers, non-rigid plastic containers, containers without tight-fitting lids, waxed paper, wax-coated freezer wrap or thin, semi-permeable wrap. The use of these wrappings could cause food odor and taste transfer and drying of frozen food.

Freezing

Do not expect your freezer to quick-freeze any large quantity of food. Put no more unfrozen food into the freezer than will freeze within 24 hours. (No more than 2 to 3 pounds of food per cubic foot of freezer space.) Leave enough space for air to circulate around packages. Be careful to leave enough room at the front so the door can close tightly. Storage times will vary according to the quality of the food, type of packaging or wrap used (air and moisture proof), and storage temperature which should be 0°F (-17.8°C).

Cleaning Your Refrigerator

Both the refrigerator and freezer sections defrost automatically. To help prevent odors, wipe up spills immediately. Clean both sections once a month.

1. Turn Refrigerator Control to OFF and unplug power cord.
2. Take out all removable parts and clean according to the following directions.

⚠ WARNING

Electrical Shock and Product Damage Hazard

- Unplug power supply cord or disconnect power supply at the fuse or circuit breaker box before cleaning your refrigerator. Failure to do so could result in electrical shock.
- Do Not use sharp instruments, window sprays, scouring cleaners or flammable fluids on your refrigerator. These can scratch or damage the material.

PART	WHAT TO USE	HOW TO CLEAN
Removable parts (shelves, crisper, etc.)	Sponge or cloth; mild detergent and warm water.	<ul style="list-style-type: none"> ▪ Wash, rinse and dry thoroughly.
Outside	Sponge, soft cloth or paper towel; mild detergent and warm water; appliance wax (or good auto paste wax).	<ul style="list-style-type: none"> ▪ Wash, rinse and dry thoroughly. ▪ Twice a year—apply appliance wax or good auto paste wax to painted metal surfaces with a clean, soft cloth. Waxing painted, metal surfaces provides rust protection. ▪ Do Not use wax on plastic parts.
Inside walls (allow the freezer walls to warm up so cloth won't stick)	Sponge, soft cloth or paper towel; mild detergent and warm water OR 2 tablespoons (26 g) baking soda to 1 quart (0.95 L) warm water.	<ul style="list-style-type: none"> ▪ Wash, rinse and dry thoroughly.
Door liners and gaskets	Sponge, soft cloth or paper towel; mild detergent and warm water.	<ul style="list-style-type: none"> ▪ Wash, rinse and dry thoroughly.
Plastics (covers and panels)	Soft, clean sponge or soft cloth; mild detergent and warm water.	<ul style="list-style-type: none"> ▪ Wash, rinse and dry thoroughly.
Defrost pan	Sponge or soft cloth; mild detergent and warm water.	<ul style="list-style-type: none"> ▪ Remove base grille. (See page 5.) ▪ Lift defrost pan over wire brace (remove any tape). ▪ Wash, rinse and dry thoroughly. ▪ Replace defrost pan with notched corner to the rear. Push pan in all the way. ▪ Check that defrost pan tubing is pointing into pan. ▪ Replace base grille. (See page 5.)
Condenser coils (behind refrigerator)	Vacuum cleaner with brush attachment.	<ul style="list-style-type: none"> ▪ Remove base grille. (See page 5.) ▪ Vacuum coils at least every other month. ▪ Replace base grille. (See page 5.)
Floor under refrigerator	Floor cleaners.	<ul style="list-style-type: none"> ▪ Move refrigerator out away from wall. ▪ Clean the floor. ▪ Move refrigerator back into place. ▪ Check levelness of refrigerator.

Caring For Your Refrigerator

If electricity goes off

1. **Call the power company.**
Ask how long power will be off.
2. **Keep freezer closed if service is to be interrupted 24 hours or less.**
This will help food stay frozen.
3. **If service is to be interrupted longer than 24 hours, do this:**
Remove all frozen food and store in a frozen food locker.
OR
Place 2 lbs. (0.9 kg) of dry ice in freezer for every cubic foot of freezer space. This will keep foods frozen for 2 to 4 days.

⚠ WARNING

Personal Injury Hazard

Wear gloves to protect your hands from dry ice burns. Failure to do so could result in dry ice burns.

OR

If dry ice or a food locker is not available, use or can perishable food at once.

NOTE: A full freezer stays cold longer than a partly filled one. A freezer full of meat stays cold longer than a freezer full of baked goods.

Food containing ice crystals may be safely refrozen, but the quality and flavor of the food may be affected.

Use refrozen food quickly. If the condition of the food is poor, or you feel it is unsafe to eat, dispose of it immediately.

Vacation and moving guide

Short vacations (less than 4 weeks)

- Use up perishable foods.
- Freeze other food items.

Long vacations (more than 4 weeks)

- Remove all food.
- Turn Refrigerator Control to OFF.
- Unplug refrigerator.
- Clean, rinse and dry the interior.
- Keep refrigerator and freezer doors slightly open by taping wood or rubber blocks at the top of each door. This allows air to enter the refrigerator and freezer sections and prevents odors and mold from building up inside while you're away.

⚠ WARNING

Personal Injury Hazard

Do Not allow children to climb on, play near or crawl inside the refrigerator when the doors are blocked open. They may become injured or trapped.

- To restart refrigerator when you return, see page 4 for resetting controls.

Moving

- Remove all food.
- Pack frozen foods in dry ice.
- Turn Refrigerator Control to OFF.
- Unplug refrigerator.
- Clean, rinse and dry the interior.
- Take out all removable parts.
- Wrap removable parts in paper and tape them all together. Store inside refrigerator.
- Raise leveling legs.
- Tape the doors shut.
- Tape the electric cord to the cabinet exterior.
- When you reach your new home, replace the removable parts and follow steps beginning on page 2.

Normal operating sounds

You can expect to hear the following sounds when your refrigerator is operating:

- **Slight hum or soft hiss** as the refrigerator's fan motor moves air.
- **Clicking or snapping** sounds occur when the refrigerator starts and stops running. The defrost timer also clicks when the defrost cycle starts and stops.
- **Water sounds** occur as water gurgles through tubing for a few minutes after refrigerator stops running. You may also hear defrost water running into the defrost-water pan.
- **Operating sounds** from the high-efficiency compressor and motor. It may run longer than your older refrigerator.

Energy saving tips

- Check the door gaskets for a tight seal. Level the refrigerator to be sure of a good seal.
- Clean dust and lint from the condenser coils every other month.
- Open the doors as seldom as possible. Decide what you need before you open the door. Remove everything you need at one time. Organize and label food so you will not have to search for items you want. Close door immediately after you remove food items.
- Store food in the refrigerator and freezer so that air movement is not blocked.
- Set the refrigerator and freezer temperatures so that the drinks remain cold enough for your family's taste and ice cream remains firm. Do Not set temperatures colder than they need to be.
- Set the Exterior Moisture Control to the OFF position unless moisture forms on the outside of the refrigerator.
- Do Not install your refrigerator next to your range, water heater, furnace, radiator, other heat sources or in direct sunlight.

Before You Call For Service

If you are having an operating problem, check the chart to see what the cause might be before you call for assistance.

OPERATING PROBLEM	CHECK IF	WHAT TO DO
Refrigerator will not run.	<ul style="list-style-type: none"> ▪ Power cord is plugged into a live circuit with proper voltage. ▪ Refrigerator Control is turned on. ▪ A household fuse has blown or circuit breaker has tripped. Also check if a time-delay fuse has been used. 	<ul style="list-style-type: none"> ▪ Firmly plug power cord into electrical outlet. Check circuit voltage at fuse/circuit breaker box. ▪ Set Refrigerator Control to a numbered setting. ▪ Replace fuse with a time-delay fuse of the correct capacity. Reset circuit breaker.
Rattling, jingling noise or unfamiliar sounds.	<ul style="list-style-type: none"> ▪ Anything is on top of or behind the refrigerator when the refrigerator is operating. ▪ These are "normal" operating sounds: humming from fans, clicking from thermostat or defrost cycle, or defrost water draining into the defrost pan. 	<ul style="list-style-type: none"> ▪ Remove objects from the top or from behind the refrigerator. ▪ Read the "Normal operating sounds" on page 8.
Automatic ice maker will not work.	<ul style="list-style-type: none"> ▪ Freezer compartment has had enough time to get cold. It may require overnight to reach the proper temperature. ▪ Signal arm is in the down (ON) position. ▪ Water valve is turned to open position and water is reaching the ice maker. 	<ul style="list-style-type: none"> ▪ Allow freezer to get cold enough. ▪ Put signal arm in the down (ON) position. ▪ Turn water valve to open position.
Water in the defrost pan.	<ul style="list-style-type: none"> ▪ Weather is hot and muggy. 	<ul style="list-style-type: none"> ▪ Hot and muggy weather can cause water to collect in the drain pan. Since water levels may reach half-full in the pan, be sure to level the refrigerator so the pan does not overflow.
Lights do not work.	<ul style="list-style-type: none"> ▪ A household fuse has blown or circuit breaker has tripped. ▪ Power cord is plugged into a live circuit with proper voltage. ▪ Bulb is burned out. 	<ul style="list-style-type: none"> ▪ Replace fuse with a time-delay fuse of the correct capacity. Reset circuit breaker. ▪ Firmly plug power cord into electrical outlet. Check circuit voltage at fuse/circuit breaker box. ▪ Replace bulb with an appliance bulb. Follow instructions on page 5.
Motor runs too long.	<ul style="list-style-type: none"> ▪ Condenser is free of lint and dust. ▪ Weather or room is hot or muggy. ▪ Door has been opened frequently or a large amount of food has been added to the refrigerator or freezer compartment. 	<ul style="list-style-type: none"> ▪ Remove dust and lint from the condenser coils with a vacuum cleaner. ▪ If the temperature outside or inside your home is warm, motor-running noises are normal. ▪ Decide which food items you need before opening the refrigerator or freezer section. Motor noise is also normal when large amounts of food are added to the refrigerator/freezer compartments. <p>Remember—your new refrigerator may be larger than your old refrigerator. It may have more space to cool, which requires a longer-running motor.</p>

**THIS PAGE
INTENTIONALLY LEFT BLANK**

**THIS PAGE
INTENTIONALLY LEFT BLANK**

LIMITED WARRANTY



Home Appliances

LENGTH OF WARRANTY (From date of purchase)	PRODUCTS COVERED	WHAT WE WILL PAY FOR
FULL ONE YEAR WARRANTY	All Roper Appliances	Replacement parts and repair labor to correct defects in materials or workmanship.
FULL FIVE YEAR WARRANTY	Refrigerators Freezers Air Conditioners Dehumidifiers	Replacement parts and repair labor for the sealed refrigeration system (compressor, evaporator, condenser, drier or connecting tubing) which we find to be defective in materials or workmanship.
LIMITED 2ND-5TH YEAR WARRANTY	Microwave Ovens	Repair or replacement of magnetron tube which we find to be defective in materials or workmanship.
LIMITED 2ND-5TH YEAR WARRANTY	Automatic Washers	Repair or replacement of any part of the gear case assembly which we find to be defective in materials or workmanship.

WHAT WE WILL NOT PAY FOR

- A. SERVICE CALLS TO:
1. Correct the installation of your appliance.
 2. Instruct you how to use your appliance.
 3. Replace house fuses or correct house wiring or plumbing.
 4. Replace owner accessible light bulbs.
- B. Repairs when appliance is used in other than normal, single-family household use.
- C. Pickup and delivery. Your appliance is designed to be repaired in the home.
- D. Damage to appliance caused by accident, misuse, fire, flood, acts of God, or use of product not approved by us.
- E. Any labor costs during the limited warranties.
- F. Repairs to parts or systems caused by unauthorized modifications made to the appliance.

This Roper appliance is warranted by Whirlpool Corporation. Under no circumstances shall it be liable under this warranty for incidental or consequential damages and all implied warranties are limited to the same time periods stated in the express warranties for Roper Brand Appliances. Some states do not allow the exclusion or limitation of incidental or consequential damages or limitations of how long an implied warranty may last, so the above limitations or exclusions may not apply to you.

This warranty gives you specific legal rights, and you may also have other rights which vary from state to state.

Outside the United States, a different warranty may apply. For details, please contact your franchised Roper distributor or military exchange.

HOW TO GET SERVICE OR ASSISTANCE

If you need service, first see the "Before You Call For Service" section of this book. If you still need service after checking this section, additional help can be found if you:

- Contact your selling dealer for the authorized servicer in your area*
OR
 - Phone 1-800-44-ROPER (1-800-447-6737) between 8:00 a.m. and 4:30 p.m. Eastern Time, Monday through Friday*
OR
 - For further information, write to: Consumer Relations Dept., Roper Brand Appliances, 2000 M-63 North, Benton Harbor, MI 49022*
- *When requesting assistance, please provide the model and serial numbers, date of purchase, and a complete description of the problem. The model and serial numbers are located on a label on the inside, left wall of the refrigerator compartment. (See illustrations on page 3.)

If you are not satisfied with the service received, contact the Major Appliance Consumer Action Panel (MACAP). MACAP is a group of independent consumer experts that voices consumer views at the highest levels of the major appliance industry. Contact MACAP only when the dealer, authorized servicer or Roper Brand Appliance warrantor have failed to resolve your problem:

Major Appliance Consumer Action Panel
20 North Wacker Drive
Chicago, IL 60606

MACAP will in turn inform us of your action.